



萬達光電科技股份有限公司

HIGGSTEC INC.

PRODUCT SPECIFICATIONS

產品規範書

Customer (客戶) : _____
Model (型式) : T170S-XDN018G-3S02R0-080PN
Mode (種類) : Projective Capacitive Touch Panel
Date (日期) : Sep. 14, 2011
Version (版本) : 2.04.01

Customer Approval

客戶簽認

HIGGSTEC INCORPORATED

8 F., No. 609, Wan Shou Rd., Sec. 1,
Kweishan, Taoyuan Hsien 33350,
Taiwan.

TEL : 886-2-8209-9696

FAX : 886-2-8200-3030

E-mail : info@higgstec.com.tw

Approve 確認	Review 審訂	Preparation 製表
Walter Chuang 9/14	Rex Chen 9/14	Dinda Lin 9/14

TABLE OF CONTENTS

目 錄

00. Specification Revision Record [規格變更記錄].....	03
00. Dimension Drawing [尺寸圖].....	04
01. Circumscription [範圍].....	05
02. Features [特性].....	05
03. General Specification [規格總則].....	05
04. Environmental Characteristics [環境特性].....	05
05. Optical Characteristics [光學特性].....	06
06. Electrical Characteristics [電子特性].....	06
07. Durability [耐久性].....	06
08. Mechanical Characteristics [機械特性].....	07
09. Reliability [信賴性].....	08
10. Linearity [線性].....	09
11. Appearance Inspection [外觀檢查].....	10
12. Attention for Mounting Condition [裝機注意事項].....	11
13. Caution [注意事項].....	12/13
14. Warranty [保固].....	14/15
15. Appendices [附註].....	15
-Appendix I [附註一] : Design Guide [設計指南].....	16/17
-Appendix II [附註一] : Appearance Specification [外觀檢查規格].....	18

TOUCHSCREEN TABULATION		
PART NUMBER	TYPE	PART NO.
XDN018G	CLEAR	

REV.	ECN NO.	DESCRIPTION	DATE
B		變更位置附註	2011.04.01
C		變更位置附註	2011.04.08
D		變更位置附註	2011.02.20

CONNECTOR PAYOUT			
PN NO.	DESCRIPTION	PN NO.	
1	SHIELDING X	1	SHIELDING X
2	X 1	2	Y 1
3	X 2	3	Y 2
4	X 3	4	Y 3
5	X 4	5	Y 4
6	X 5	6	Y 5
7	X 6	7	Y 6
8	X 7	8	Y 7
9	X 8	9	Y 8
10	X 9	10	Y 9
11	X 10	11	Y 10
12	X 11	12	Y 11
13	X 12	13	Y 12
14	X 13	14	Y 13
15	X 14	15	Y 14
16	X 15	16	Y 15
17	X 16	17	Y 16
18	X 17	18	Y 17
19	X 18	19	Y 18
20	X 19	20	Y 19
21	X 20	21	Y 20
22	X 21	22	Y 21
23	X 22	23	Y 22
24	X 23	24	Y 23
25	X 24	25	Y 24
26	X 25	26	Y 25
27	X 26	27	Y 26
28	X 27	28	Y 27
29	X 28	29	Y 28
30	X 29	30	Y 29
31	X 30	31	Y 30
32	X 31	32	Y 31
33	X 32	33	Y 32
34	X 33	34	Y 33
35	X 34	35	Y 34
36	X 35	36	Y 35
37	X 36	37	Y 36
38	X 37	38	Y 37
39	X 38	39	Y 38
40	X 39	40	Y 39
41	X 40	41	Y 40
42	X 41	42	SHIELDING X
43	X 42		
44	X 43		
45	X 44		
46	X 45		
47	X 46		
48	X 47		
49	X 48		
50	X 49		
51	X 50		
52	SHIELDING X		
53	N/A		
54	N/A		

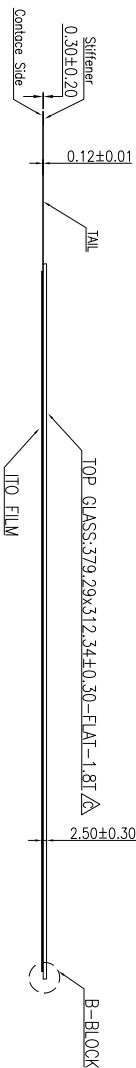
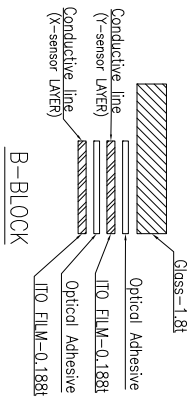
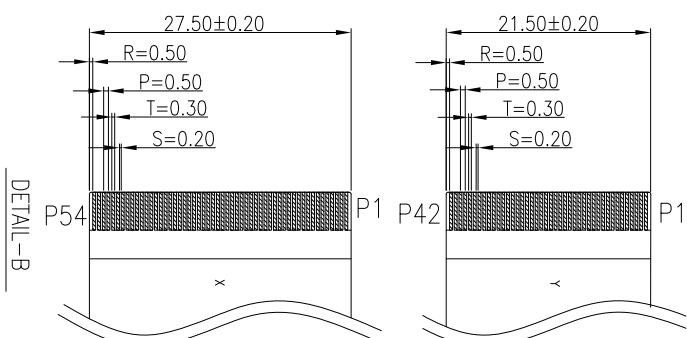
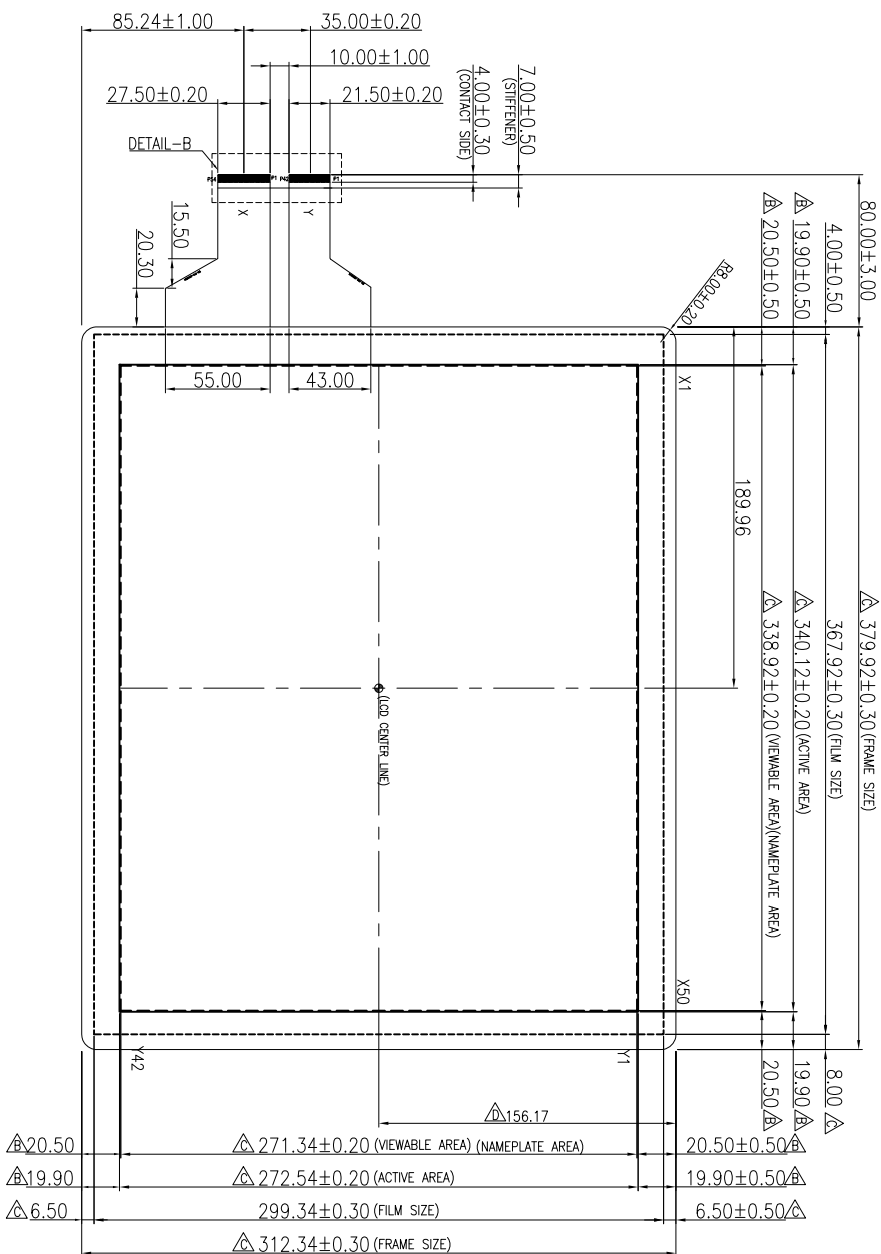

HIGGESTEC INC.

DESCRIPTION	DATE	APPROVED	Rev.	D
WD-TCP-0528	SEP.20, 2011	<i>Steven</i>		
MODEL	SCALE	DESIGN	Page	of
T170S-XDN018X-3S02R0-080PN	-/-	<i>Andy</i>		
UNIT	DRAWING	of	B-Page	of
mm.	<i>Emma</i>			

01. Circumscription The specification is for Projected Capacitive Touch Panel modules.

[範圍]

[此規格適用於投射電容式觸控屏幕]

02. Features

[特性]

Item [項目]		Specifications [規格]
(1)	Type [型式]	Projective Capacitive [投射電容式]
(2)	Input Mode [操作模式]	Finger [手觸]
(3)	Connector [連接方式]	FPC

03. General Specification

[規格總則]

Item [項目]		Specifications [規格]
(1)	Frame Size [外框尺寸]	379.92±0.30 X 312.34±0.30 mm
(2)	View Area [可視區]	338.92±0.20 X 271.34±0.20 mm
(3)	Active/Precision Area [動作區]	340.12±0.20 X 272.54±0.20 mm
(4)	Total Thickness [總厚度]	2.50±0.30 mm
(5)	Tail Length [出線長度]	80.00±3.00 mm
(6)	I/O Channel [出線 pin 腳數]	X=54pin / Y=42pin

04. Environmental Characteristics

[環境特性]

Item [項目]		Specifications [規格]	
		Temperature [溫度]	Humidity [濕度] (Non Condensing) [不可結露]
(1)	Operation [操作]	-20°C ~ +70°C	20%RH~85%RH
(2)	Storage [儲存]	-40°C ~ +80°C	10%RH~90%RH

Note: Testing environment is under normal atmosphere pressure.

[註:於正常的 1 大氣壓下]

※When the ambient temperature is above 65°C, the humidity is allowed to be below 50%RH .

[65°C 以上高溫環境時，濕度允許在 50%RH 以下]



05 Optical Characteristics

[光學特性]

Item [項目]		Specifications [規格]
(1)	Transparency [透光度]	90% ± 3%
(2)	Haze [霧化度]	< 2%

※measured by BYK-Gardner

06 Electrical Characteristics

[電子特性]

Item [項目]		Specifications [規格]
(1)	Response [作動時間]	According to Integration time of controller
(2)	Insulation [絕緣阻抗]	$\geq 100\text{M}\Omega/25\text{V}(\text{DC})$
(3)	Linearity [線性]	$X \leq 1.0\%$, $Y \leq 1.0\%$ (See Figure 10-1)

07 Durability

[耐久性]

Item [項目]		Specification [規格]
(1)	Knock Test [觸擊測試]	100,000,000 times (1 億次)

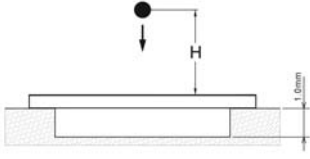
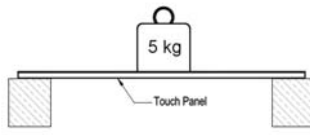
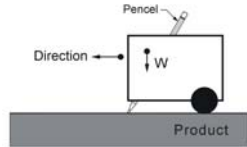
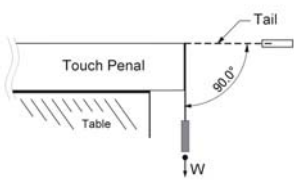
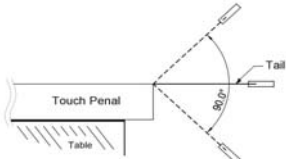

08. Mechanical Characteristics
[機械特性]

Item [項目]		Condition [條件]	Specification [規格]
(1)	Operating Force [作動力]	Finger $\leq 10g$ [手觸 $\leq 10g$]	Satisfy- 1. Optical Characteristics. 2. Electrical Characteristics. Appearance- 1. Ignore test area 2. No mechanical damage.
(2)	Impact [撞擊]	25.0 ϕ DIA. Steel Ball/67g Height=30cm / 1 time, Impact at center area [25 ϕ /67g 不銹鋼球：高度=30cm/中央區域撞擊 1次] 	
(3)	Static Load [靜態承重]	5000g within 10cm ϕ area for 30sec [5000g 置於 10cm ϕ 內，靜置 30 秒] 	
(4)	Hardness [硬度]	7H pencil, pressure 750g/45° [鉛筆 7H, 壓力 750g/45° (ASTM D3363)] 	
(5)	Tail Peeling [剝離]	800g/cm by vertical 90° for 30sec [800g/cm, 垂直 90°, 靜置 30 秒] 	
(6)	Tail Bending [繞折]	90° 10 times left & right [90° 角, 左右來回 10 次] 	

09. Reliability

[信賴性]

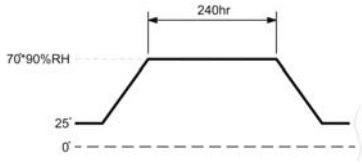
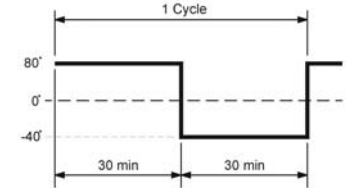
	Item [項目]	Condition [條件]	Specification [規格]
(1)	Constant Temperature / Humidity [恆溫恆濕]	70°C X 90%RH, 120 hrs and normalized for 4 hrs [70°CX90%RH, 120 小時, 回常溫 4 小時後始可測試] 	Satisfy- 1.Electrical Characteristics.
(2)	Heat Cycle [高溫循環]	70°C /120 hrs and normalized for 4 hrs [70°C /120 小時, 回常溫 4 小時後始可測試]	
(3)	Cold Cycle [低溫循環]	-40°C /120 hrs and normalized for 4 hrs [-40°C /120 小時, 回常溫 4 小時後始可測試]	
(4)	Thermal Cycle [冷熱循環]	-40°C ~80°C [60 min./cycle] *10 cycles and normalized for 4 hrs [-40°C ~80°C, 每循環 60 分鐘, 共 10 次循環, 回常溫 4 小時後始可測試] 	



10. Linearity :

[線性]

(1) Linearity Condition [線性測試條件]

Measure the product output data when a brass finger connected with GND is traced a straight line AB. ΔE is the maximum output difference when a brass finger traces A to B. AB is the end and the end in an active area. Linearity is expressed by the following equation. (Fig 10-1)

[產品量測數據時，一銅手指連接接地為一條直線導體。 ΔE 為最大輸出差距，銅手指的軌跡從A到B為基礎，線性表現由下面的公式。] (Fig 10-1)

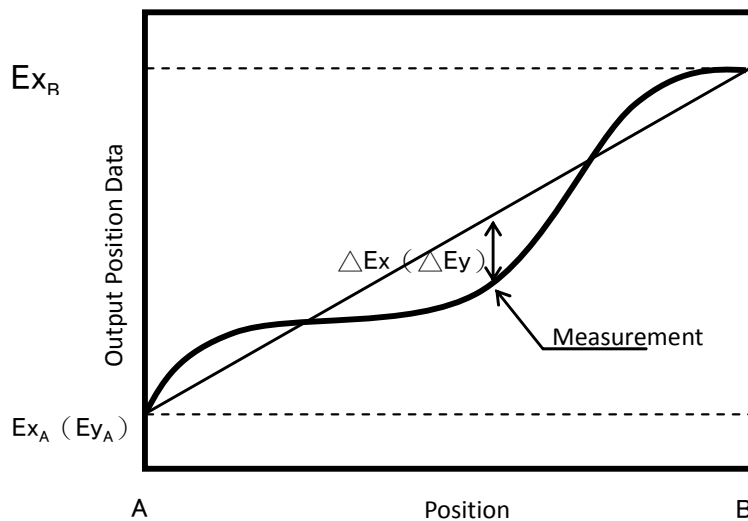

(Fig 10-1)

$$\begin{aligned} \text{X directional linearity} &= (\Delta E_x / \Delta E_{x_{a-b}}) \times 100[\%] \\ \text{Y directional linearity} &= (\Delta E_y / \Delta E_{y_{a-b}}) \times 100[\%] \end{aligned}$$

※ Test Tool: Brass Finger

[測試工具]: 黃銅手指

Cylindrical brass bar simulating a fingertip used in measurement and testing.

[模擬指尖，由黃銅製成，為測量和測試]

(2) Specification [規格]

linearity must be meet the electrical specification outlined in Item 6

[線性必須符合 6 項目的電性規範]

11. Appearance Inspection

[外觀檢查]

(1) The inspection was performed with two 20W(1800±500 LUX) fluorescent lamp lighting from back or side. The panel was placed 45cm away from eyes. (Figure 11-1).
 [(1) 檢測始用之燈光為二盞 20W(1800±500 LUX)白熾燈光，並於面板後側或上側照射，檢測時須放置在離眼睛 45cm 處(Figure11-1)]

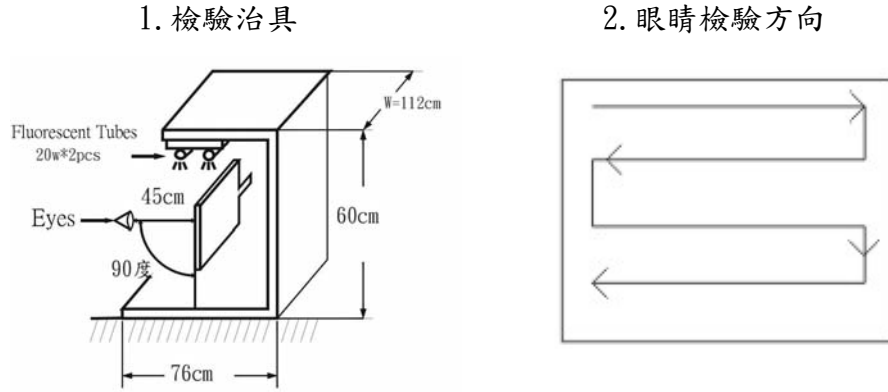

Figure 11-1

(2) Glass Flaw [玻璃瑕疵]

Item [項目]	Picture [圖示]	Specification [規格]
Corner Flaw [角瑕疵]		$X \leq 3.0\text{mm}$ $Y \leq 3.0\text{mm}$ $Z \leq T$
Edge Flaw [邊緣瑕疵]		$X \leq 3.0\text{mm}$ $Y \leq 3.0\text{mm}$ $Z \leq T$
Progressive Flaw [裂縫瑕疵]		Not allowed [不允許]

Note: T=Glass thickness

(3) Please refer to AppendixII : Appearance Specification.

[(3)外觀規格請詳見(附註 2)]



12.

(1)	<p>The gasket support of touch panel must be designed on the outside of Viewable area, as well as to avoid pressing on touch panel accidentally, the enclosure must be designed with enough clearance to panel surface. To avoid pressing error on touch panel accidentally, please remain space between the surface of panel and the Bezel. (Figure 12-1)</p> <p>[請將固定觸控屏用的支撐體(support)設計於可視區(Viewable area)之外。為避免不小心碰到觸控屏而產生動作，請預留空間於面板與機體外殼之間](圖示 12-1)</p>
(2)	<p>We recommend elastic material made support.</p> <p>[建議使用彈性物質製成的支撐體]</p>
(3)	<p>The edge of touch panel is conductive. Don't touch it with metal after mounting.</p> <p>[觸控屏面板四周有可能會導電，安裝時後請勿與其他金屬物質接觸]</p>
(4)	<p>Please take notice of the grounding of power while mounting the touchscreen, otherwise it may have unstable situation.</p> <p>[電容式觸控螢幕的組裝必須注意電源的接地，可能因外界干擾會有作動不穩定的情況發生]</p>
(5)	<p>Please do not pull on flex tail during assembly. Do not bend at 90° and each bend angle should be no less than R:5m/m.</p> <p>[組裝時不可拉扯 TAIL 訊號線，且不可直接彎折 90° 每處彎曲處都需保持最小 R 角(R=5m/m)]</p>
(6)	<p>During assembly, the touch panel must be securely affixed onto the LCD Panel to prevent displacement of the touch panel due to outside force pressing on touch screen or bezel/case.</p> <p>[電容式觸控面板與 LCD Panel 組裝時，必須確實黏貼固定，不可因外力按壓觸控面板或機殼，而造成觸控面板晃動偏移。]</p>

Projective Capacitive Touch Panel Assembly Guide + Touch Windows

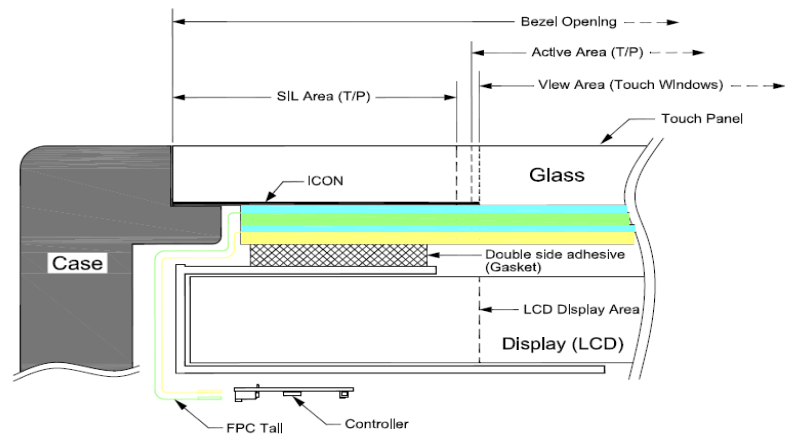

Figure 12-1

13. Caution

[注意事項]

Storage [儲存]	<p>(1)Store panel under the temperature and humidity range pre-specified. Direct sunlight exposure or piling should be avoided. [儲存要注意溫/濕度條件，且不可直接暴露於陽光下，或堆疊造成直接加壓面板]</p> <p>(2)Ship Method (1)must use legal couriers to transport products.(2) fragile products ; beware of vibration and dropping during transit. [搬運方法 (1)需顧用合法搬運公司進行貨物離置 (2)產品為易碎品,搬運時需注意震動、掉落]</p> <p>(3)Stacking method (a)based on standard air/ocean freight regulation (b) pallet use recommended for stacking (c) monitor stack weight and height to prevent damage to bottom stack. [堆疊方法 (a)依空運或海運堆放標準 (b)建議利用棧板進行堆疊作業 (c)注意堆疊重量及高度,不可造成最下層包裝箱發生變形或破損]</p>
Unpack [拆裝]	<p>(1)Unpack the box with the printed red arrow pointing up. [注意檢查包裝箱已發現來貨外箱已有嚴重變形或破損時,應立即拍照佐證，以避免損壞]</p>
Handing [握持]	<p>(1) Use clean sacks or glove to prevent fingerprints and/or stains left on the panel. Extra attention and carefulness should be taken while handling the glass edge. [配戴清潔的指套、手套、口罩，以避免造成指紋、髒污或不小心被玻璃邊緣割傷]</p> <p>(2) Avoid touching the viewing area before installation/integration. [安裝組合時，避免直接接觸可視區]</p> <p>(3) Holding the panel instead of the tail at all time. [拿取面板時，不可直接拿取 tail 部份]</p>
Cleaning [清潔]	<p>(1) Use neutral detergent or isopropyl alcohol on a clean soft cloth to clean the panel surface. [使用乾淨且柔軟的布，沾中性清潔劑或酒精進行清潔]</p> <p>(2) Prevent using any kind of chemical solvent, acidic or alkali solution. [不能使用化學溶劑或酸鹼液進行清潔]</p> <p>(3) Foreign objects and prints that can be wiped off are not regulated under the specification , can be ignored. [表面可擦拭及排除的異物及異紋並不列入判定規範內,可被乎略]</p>



<p>Installing and Assembling [組合與裝配]</p>	<p>(1) Excessive force or strain to the panel or tail is prohibited. [注意避免加壓或拉扯面板及 tail]</p> <p>(2) Retain at least 3.0 mm clearance between panel and display module. [最少保留 3.0mm 的空間於面板及顯示器之間]</p> <p>(3) Gasket or cushion pads around the edge of the panel may segregate water and/or dust contamination. [在設計機構時，注意四周邊緣需有緩衝墊，以避免滲水或聚集灰塵]</p> <p>(4) Maintain a minimal 5R when bending tail to prevent dead fold or fold mark. [組裝時應保持最小 5R 的折彎尺寸，並避免死折或有折痕現象]</p> <p>(5) Flaws in customer module design may cause functionality issues after assembly. [客戶端設計模組若有疏失時，會造成觸控屏組裝後，產生變形或破損現象會影響正常觸控功能]</p>
<p>Operating [操作]</p>	<p>(1) Touch the panel with your finger or stylus only to assure normal operation. Any sharp edged or hard objects are prohibited. [應用手指或專用觸控工具，不能使用尖銳、堅硬的物體書寫輸入]</p> <p>(2) Operate the panel in a steady environment. Abrupt variation on temperature and humidity may cause malfunction of the panel. [急遽的溫/濕度變化會有結露現象，易造成面板功能失效，所以穩定的環境條件是必要的]</p> <p>(3) Avoid applying excessive activation force or sudden impact on the panel surface. [避免應用過大觸動力或瞬間衝擊面板表面]</p> <p>(4) Avoid high voltage and/or static charge. [避免高壓與靜電]</p>
<p>Test [測試]</p>	<p>(1) During the measurement, the brass finger must connect to ground. [使用黃銅手指測量時必須接地]</p> <p>(2) The whole brass finger footprint must be inside the active area. [使用黃銅手指測量需於 A. A. 區內部有效的區域]</p>
<p>Others [其他]</p>	<p>(1) Keep the panel surface clean. Prevent any kind of adhesive applied on the surface. [請保持表面清潔，不要貼膠帶於面板上]</p> <p>(2) HIGGSTEC has the right to change the materials and/or specifications. [萬達光電保有變更規格及材料的權利]</p>



14. Warranty

[保固]

(1)	<p>HIGGSTEC offers a 2-year warranty on all HIGGSTEC products. HIGGSTEC guaranty provide for repair and replacement without any charge during this period.</p> <p>HIGGSTEC reserves the right in its sole discretion to determine the defects received, and will take the responsibility if there is any defect or damage.</p> <p>[除了下列 4 點所述外，萬達光電所生產製造的產品保固期限為 2 年，若判定為萬達光電之責任，則產品更換。萬達光電保留判定責任歸屬之權益]</p>
(2)	<p>Limited warranty does not cover the following situations:</p> <p>[有限度保固，不包括下列幾點]</p> <p>【Notice】</p> <p>HIGGSTEC is not responsible for following situation:</p> <ol style="list-style-type: none">1. Damages caused by improper handling from clients, such as the shipping period or manufacturing processes. [在客戶的製程或運輸中,因客戶自身疏忽所造成對產品的傷害及破損]2. Damages caused by either natural disaster or human factors after receiving the products. [在客戶收到萬達光電之產品後,因為天災人禍所造成的傷害及破損]3. Damage caused by self-repairs, and modifications or disassembling of HIGGSTEC products from clients without prior notice. [沒有知會萬達光電共同討論，而自行變更、維修、拆卸產品所造成的傷害及破損]4. Damage caused by user error ; failing to follow normal operation procedures or using paper tools. [客戶端於觸控屏使用操作上,該使用正確的動作及工具操作觸控屏,因客戶未依正確操作使用造成產品傷害及破損]5. Product serial numbers and/or labels must remain intact or clearly visible for tracking purpose; otherwise, warranty is voided. [產品條碼需保留完整清晰以利追溯，其不完整時故無法保固]



(3)

1.This document is a property of HIGGSTEC. The information contained herein is deemed Confidential and Proprietary and may not be reproduced or disclosed to third parties without prior written consent of HIGGSTEC.

[這份文件是萬達的財產，所包含的信息均被視為機密或專有，未經萬達事先書面同意不得複製或透露給第三方]

2. HIGGSTEC disclaims any warranty that any use of such devices shall be free from infringement of any third party's intellectual property rights of other proprietary rights, and further, assumes no liability of whatsoever nature in the event of any such infringement, or arising from or connected with or related to the use of such devices.

[萬達公司其產品提供給客戶端進行整體設計組裝後，除本產品外若有其他發生違反相關智慧財產權及任何所有權之爭議部份，則不做任何擔保]

3. The information contained herein are subject to change without notice due to product improvement or other reasons. Therefore please request for the latest product information upon actual use.

[此文件的資料會因該產品改善亦或其他因素而有改變。請在有確切需要時向萬達索取最新產品資料版本]

15. Appendices

[附註]

Item [項目]	Content [內容]
Appendix I [附註一]	Design Guide[設計指南]
Appendix II [附註二]	Appearance Specification[外觀檢查規格]

<p>1. Projected capacitive [投射式電容]</p>	<p>Using a matrix type electrode pattern and matching software/hardware & IC to measure the change in capacitance for determining a touch actuation in single- and multiple-touch multi-functioning applications. [設計藉由矩陣式的電極圖案及搭配軟、硬體、IC 等，並主要利用電容量的變化，來判斷觸控動作的產生，以展現單點及多點觸控多功能的應用]</p>
<p>2. Product area definition [產品區域定義]</p>	<div style="text-align: center;"> </div> <p>A. Frame Size [產品外型尺寸]</p> <p>B. Viewable Area [可視區：與 LCD 搭配時約為鐵框內緣，且為設計銀線路最小範圍，此區域無觸控功能]</p> <p>C. Active Area [該區域內可執行觸控動作之範圍]</p> <p>D. Tail [傳輸電壓及電容訊號用]</p>

4.	Silver trace layout area [銀線設計區]	<p>As shown in the illustration, the tail side marked ① is where the traces converge, thus requiring more width.</p> <p>[依上圖所示，將產品4邊個編上號碼，其Tail端為編號①其他各邊則為②③④，因①邊需匯集所有訊號線，故其邊寬尺寸會需較大空間，其所需尺寸會依實際線數而定，若有任何設計上需求可與萬達討論後提供最佳方案]</p>
5.	Material selection [材料選擇]	<p>1. ITO Glass Thickness: 0.7t / 1.1t / 1.6t / 1.8t / 2.5t / 2.8t (mm), it is recommended to use thicker glass for larger size panels; chemical strengthening optional. ITO resistance setting and selection is based on Higgstec product design. [厚度為 0.7t / 1.1t / 1.6t / 1.8t / 2.5t / 2.8t(mm)，建議大尺寸面板其選用較厚 Glass 亦可依特殊需求增加化學強化] [ITO 阻抗設定及選用，依萬達設計為主]</p> <p>2. ITO Film Thickness: 0.125t / 0.188t (mm), current industry standard uses 0.188t mainly; the optic treatment can be AG or AR; surface hardness 2-3H. ITO resistance setting and selection is based on Higgstec product design. [厚度為 0.125t / 0.188t(mm)，目前業界都以 0.188t 為主要選擇，其外觀特性亦可選擇亮/霧面處理，表面硬度為 2-3H] [ITO 阻抗設定及選用，依萬達設計為主]</p> <p>3. Tail FFC and FPC types: copper inlay allow high conductivity; can add Housing or ZIF component. FFC can withstand up to 105 C and FPC up to 200 C; FPC material allows a smaller bending angle. FFC signal count is 2-50pins, less capable to change shape/form but cost less. FPC has unlimited signal count; can be versatile in shape to conform to structural design. [種類分為 FFC/FPC 兩種，兩者都為銅導線其導電係數都非常良好，皆可於前端部份增加 Housing 或 ZIF 原件，因材料關係 FFC 可耐溫 105 度而 FPC 可耐溫約 200 度，FPC 材料較薄可提供較小的繞折角度] [FFC 訊號數為 2-50pin，外型較無法依結構需求變化，但單價較經濟] [FPC 訊號數為無限制，外型較可依結構需求變化，但單價較昂貴]</p>
6.	Other sub-material [其他複屬材]	<p>For special requirements such as gasket, Poron, polarizer and insulation, etc. Higgstec can offer optimum solution upon request.</p> <p>[如有特殊需求，例如需增加 Gasket、Poron 或偏光材及絕緣材等等，可與萬達討論後提供最佳方案]</p>
7.	Suitable applications [產品適用範圍]	<p>Suitable for all applications. Not recommended for use in high EM interference environment.</p> <p>[全方位均可適用，但需注意不建議使用於環境為高電磁干擾區域]</p>

Appendix II [附註二]

Appearance Specification[外觀檢查規格]

	Item [項目]	Specification [規格]	
		A - Area	B - Area
1.	Scratch 【刮傷】	(1) $W \leq 0.20 \rightarrow OK$ (2) $0.20 < W \leq 0.25$ ($L \leq 25$, total ≤ 5) $\rightarrow OK$ (3) $W > 0.25 \rightarrow NG$	同 A-Area
2.	Air Bubbles 【汽泡/透明】	(1) $D \leq 1.5 \rightarrow OK$ (2) $1.5 < D \leq 1.7$ (total ≤ 5) $\rightarrow OK$ (3) $D > 1.7 \rightarrow NG$	(1) $D \leq 1.8 \rightarrow OK$ (2) $1.8 < D \leq 2.0$ (total ≤ 7) $\rightarrow OK$ (3) $D > 2.0mm \rightarrow NG$
3.	Linear Object 【線狀異物/毛屑】	(1) $W \leq 0.2 \rightarrow OK$ (2) $0.2 < W \leq 0.25$ ($L \leq 25$, total ≤ 5) $\rightarrow OK$ (3) $W > 0.25 \rightarrow NG$	(1) $W \leq 0.15 \rightarrow OK$ (2) $0.15 < W \leq 0.25$ ($L \leq 35$, total ≤ 7) $\rightarrow OK$ (3) $W > 0.25 \rightarrow NG$
4.	Particle White Spots 【白色點狀】	(1) $D \leq 0.8 \rightarrow OK$ (2) $0.8 < D \leq 1.0$ (total ≤ 5) $\rightarrow OK$ (3) $D > 1.0 \rightarrow NG$	(1) $D \leq 0.5 \rightarrow OK$ (2) $0.5 < D \leq 0.7$ (total ≤ 7) $\rightarrow OK$ (3) $D > 0.7 \rightarrow NG$
5.	Particle Black Spots 【黑色點狀】	(1) $D \leq 0.5 \rightarrow OK$ (2) $0.5 < D \leq 0.6$ (total ≤ 5) $\rightarrow OK$ (3) $D > 0.6 \rightarrow NG$	同 A-Area

< Remark > 【備註欄】

- Finished appearance of the edge of broken glass, according to test specifications for testing.
[玻璃邊緣破損依成品外觀檢驗規範進行檢驗。]
- Outlet hole edge damage is negligible.
[出線孔邊緣破損忽略不計。]
- Reference to the figure within the sub-AA standards, FS \rightarrow AA test between the standard.
[參照上圖分 AA 內規範，FS \rightarrow AA 之間檢驗規範]
- Look beyond the flaws in the back of AA Jieke ignored.
[背面 AA 以外的外觀瑕疵皆可忽略。]
- D=Diameter=直徑。
- W=Width=寬度。
- L=Length=長度。
- $D \leq 0.13mm$ 可忽略不計 $\rightarrow OK$ 。

